

# Helixon-S



①



②

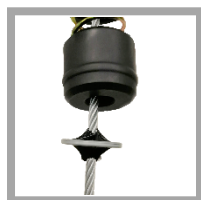

③









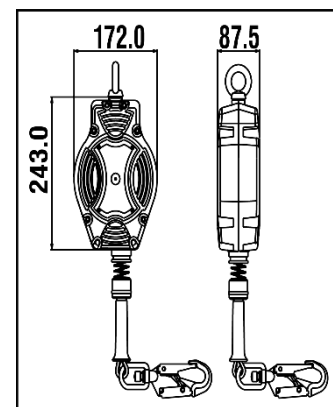



④



⑤



HS CODE
84798997
CARTON SIZE / PCS.
60 x 40 x 24 cm / 4
AET N° 2777/10829-02/E08-01
<b>Satra Technology Europe Ltd., N° 2777,</b> Bracetown Business Park, Clonee, Dublin, D15YN2P, Ireland
MODULE D FI14/14003.02
<b>SGS Fimko Oy, N°0598</b> Takomotie 8, 00380 HELSINKI, Finland

REF.	FA 20 402 10
LG.  KG	10 m
CE	EN 360:2002
MAT.  	Polyamide 6 - 30% fiber glass
	 STEEL Ø4.8 mm
	 FA 50 101 17 / FA 50 203 20 with fall indicator
	x2
R(kN)	12 kN
	YES – 100 KG
+	VG11.060 – Rev. 08 – 10/2014
	4.57 KG

LG.  
 KG

**Longueur** Poids maxi utilisateur  
**Length** Max. user weight  
**Longitud** Peso máximo del usuario  
**Lunghezza** Peso Max. dell'utente  
**Länge** Höchstgewicht des Benutzers

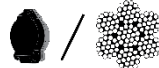
MAT.  

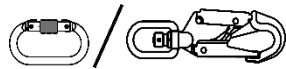

**Matière carter / câble**  
Material of casing / wire rope  
**Material cárter / cable**  
Material dei carter / cavo  
**Material Gehäuse / Seil**



**Matière connecteur haut / connecteur bas**  
Material of top connector / bottom connector  
**Material conector alto / conector bajo**  
Materiale connettore alto / connettore basso  
**Material oberes / unteres Verbindungselement**



**Nombre d'émerillons**  
Number of swivels  
**Cantidad de eslabones giratorios**  
Numero di tornichetti  
**Anzahl der Wirbel**



**Homologué pour le travail à proximité d'arêtes vives**  
Approved for work near sharp edges  
**Homologado para trabajo cerca de aristas vivas**  
Omologato per lavoro in prossimità di spigoli vivi  
**Zugelassen für Arbeiten in der Nähe scharfer Kanten**